

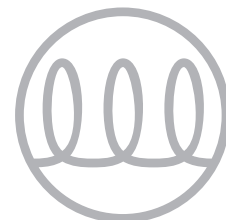

# Use & Care Guide

## Induction Cooktop



 **Electrolux**

## 2 Finding Information

---

### MAKE A RECORD FOR FUTURE USE

---

Brand \_\_\_\_\_

Purchase Date \_\_\_\_\_

Model Number \_\_\_\_\_

Serial Number \_\_\_\_\_

#### **NOTE**

The serial and model numbers may be found on the serial plate located under the cooktop.

### QUESTIONS?

---

For toll-free telephone support in the U.S. and Canada:  
**1-877-4ELECTROLUX (1-877-435-3287)**

For online support and internet product information:  
**[www.electrolux.com](http://www.electrolux.com)**

## TABLE OF CONTENTS

<b>Finding Information</b> .....	<b>2-3</b>	<b>General Care &amp; Cleaning</b> .....	<b>19-20</b>
Make a Record for Future use .....	2	Ceramic Glass Cooktop Cleaning & Maintenance ...	19
Questions? .....	2	Cleaning Recommendations for Ceramic Glass Cooktop .....	19-20
<b>Safety</b> .....	<b>4-6</b>	<b>Solutions to Common Problems</b> .....	<b>21-23</b>
Important Safety Instructions .....	4	Entire Cooktop Does Not Operate .....	21
<b>Induction Cooktop Features</b> .....	<b>7-8</b>	Cooktop Turns Off While Cooking .....	21
<b>Induction Cooktop Display Messages</b> .....	<b>9-10</b>	Cooking Zone Does Not Heat Food .....	21
LED Messages or Light Indicators Displayed by Main Control .....	9	Cooking Zone Heats Food Too Hot or Not Enough .....	22
LED Messages or Light Indicators Displayed by Cooking Zone Controls .....	9-10	Food Does Not Heat Evenly .....	22
<b>Before Using the Cooktop</b> .....	<b>11-13</b>	Poor Cooking Results .....	22
Use the Correct Cookware Type .....	11	Cooktop Zone Control Displays <i>E</i> and 2 Digits LED Main Control Displays <i>00</i> , <i>03</i> , <i>04</i> , <i>05</i> , <i>06</i> or <i>07</i> .....	22
Minimum Pan Size Requirements for Each Cooking Zones .....	11	Cooking Zone LED Continuously Flashes <i>F</i> .....	22
Cookware Recommendations .....	12	Metal Marks on Ceramic Cooktop Glass .....	23
Use Quality Cookware in Good Condition .....	13	Scratches or Abrasions on Ceramic Cooktop Glass .....	23
<b>Setting Surface Controls</b> .....	<b>14-18</b>	Brown Streaks or Specks on Ceramic Cooktop Surface .....	23
Using the Touch Control .....	14	Area of Discoloration with Metallic Sheen on Ceramic Cooktop Glass .....	23
Operating the Cooking Zones .....	14-15	<b>Warranty Information</b> .....	<b>24</b>
Preheat Recommendations .....	16		
Keep Warm Feature .....	16		
Minute Timer .....	17		
Locking the Controls .....	17		
Power Sharing .....	18		
Operational Noises .....	18		

# 4 Safety

## IMPORTANT SAFETY INSTRUCTIONS

Read all instructions before using this appliance. Save these instructions for future reference. This manual contains important safety symbols and instructions. Please pay attention to these symbols and follow all instructions given.

### **WARNING**

This symbol will help alert you to situations that may cause serious bodily harm, death or property damage.

### **CAUTION**

This symbol will help alert you to situations that may cause bodily injury or property damage.

### **WARNING**

To reduce the risk of fire, electrical shock, or injury when using your electric cooktop, follow basic precaution including the following:

This unit has been tested and found to comply with the limits for a class B digital device, pursuant to Part 18 of the FCC rules. These limits are designed to provide reasonable protection against harmful interference in a residential installation. This unit generates, uses and can radiate radio frequency energy and, if not installed and used in accordance with the instructions, may cause harmful interference to radio communications. However there is no guarantee that interference will not occur in a particular installation. If this unit does cause harmful interference to radio or television reception, which can be determined by turning the unit off and on, the user is encouraged to try to correct the interference by one or more of the following measures:

- Reorient or relocate the receiving antennae.
- Increase the distance between the unit and receiver.
- Connect the unit into an outlet or a circuit different from that to which the receiver is connected.

### **CAUTION**

Persons with a pacemaker or similar medical device should exercise caution using or standing near an induction unit while it is in operation, as the electromagnetic field may affect the working of the pacemaker or similar medical device. It would be advisable to consult your Doctor or the pacemaker or similar medical device manufacturer about your particular situation.

- **Remove all tape and packaging wrap before using the appliance. Destroy the carton and plastic bags after unpacking the appliance.** Never allow children to play with packaging material.
- **Proper Installation. Be sure your appliance is properly installed and grounded by a qualified technician in accordance with the National Electrical Code ANSI/NFPA No. 70 - latest edition in the United States, or CSA Standard C22.1, Canadian Electrical**

**Code, Part 1, in Canada, and local code requirements.** Install only per installation instructions provided in the literature package for this appliance.

Ask your dealer to recommend a qualified technician and an authorized repair service. Know how to disconnect the electrical power to the appliance at the circuit breaker or fuse box in case of an emergency.

- **User Servicing. Do not repair or replace any part of the appliance unless specifically recommended in the manuals.** All other servicing should be done only by a qualified technician to reduce the risk of personal injury and damage to the appliance.
- **Never modify or alter the construction of an appliance such as removal of panels, wire covers or any other permanent part of the product.**
- **Storage on Appliance. Flammable materials should not be stored near or on the cooking surface.** This includes paper, plastic and cloth items, such as cookbooks, plasticware and towels, as well as flammable liquids. Do not store explosives, such as aerosol cans, on or near the appliance. Flammable materials may explode and result in fire or property damage.

## CAUTION

Do not store items of interest to children in the cabinets above the appliance. Children climbing on the cooktop to reach items could be seriously injured.

- **Do not leave children alone. Children should not be left alone or unattended in the area where an appliance is in use.** They should never be allowed to sit or stand on any part of the appliance.

## CAUTION

**DO NOT TOUCH COOKING ZONES OR AREAS NEAR THESE SURFACES.** Cooking Zones may be hot from residual heat even though they are dark in color. Areas near the Cooking Zones may become hot enough to cause burns. During and after use, do not touch, or let clothing or other flammable materials touch these areas until they have had sufficient time to cool.

## WARNING

Never use your appliance for warming or heating a room.

- **Wear Proper Apparel. Loose-fitting or hanging garments should never be worn while using the appliance.** Do not let clothing or other flammable materials contact hot surfaces.
- **Do Not Use Water or Flour on Grease Fires. Smother the fire with a pan lid, or use baking soda, a dry chemical or foam-type extinguisher.**
- **When heating fat or grease, watch it closely.** Fat or grease may catch fire if allowed to become too hot.
- **Use Only Dry Pot holders. Moist or damp pot holders on hot surfaces may result in burns from steam.** Do not let the pot holders touch hot surface units. Do not use a towel or other bulky cloth instead of a pot holder.
- **Do Not Heat Unopened Food Containers. Buildup of pressure may cause the container to burst and result in injury.**

# 6 Safety

## IMPORTANT SAFETY INSTRUCTIONS FOR USING YOUR COOKTOP

- **Know which touch key pads controls each surface of the Cooking Zones.**
- **Clean the appliance regularly to keep all parts free of grease that could catch fire.** Exhaust fan ventilation hoods and grease filters should be kept clean. Do not allow grease to accumulate on hood or filter. Greasy deposits in the fan could catch fire. When flaming food under the hood, turn fan on. Refer to hood manufacturer's instructions for cleaning.
- **Use Proper Pan Size.** This appliance is equipped with one or more Cooking Zones of different sizes. Select utensils having flat bottoms large enough to cover the Cooking Zones. The pan detection sensors will not allow the affected Cooking Zones to operate without a pan present.
- **Utensil Handles Should Be Turned Inward and Should Not Extend Over Adjacent Cooking Zones.** To reduce the risk of burns, ignition of flammable materials, and spillage due to unintentional contact with the utensil.
- **Never Leave Prepared Food on the Cooking Zones.** Boilovers cause smoking and greasy spillovers that may ignite, or a pan that has boiled dry may melt or become damaged.
- **Protective Liners.** Do not use aluminum foil to line any part of the cooktop. Only use aluminum foil as recommended after cooking process, if used as a cover to be placed over the food. Any other use of aluminum foil may result in the risk of electric shock, fire or short circuit.
- **Glazed Cooking Utensils.** Only certain types of glass, glass/ceramic, ceramic, earthenware, or other glazed utensils are suitable for range top service without breaking due to the sudden change in temperature. Check the manufacturer's recommendations for cooktop use.
- **Ventilating hood.** The ventilating hood above your cooking surface should be cleaned frequently, so the grease from cooking vapors does not accumulate on the hood or filter.

## FOR CERAMIC-GLASS COOKTOP ONLY

- **Do Not Clean or Operate a Broken Cooktop.** If cooktop should break, cleaning solutions and spillovers may penetrate the broken cooktop and create a risk of electric shock. Contact a qualified technician immediately.
- **Clean Cooktop with Caution.** If a wet sponge or cloth is used to wipe spills on a hot cooking area, be careful to avoid a steam burn. Some cleaners can produce harmful fumes if applied to a hot surface.
- **Do Not Place Hot Cookware on Cold Cooktop Glass.** This could cause glass to break.
- **Do not slide pan across the cooktop surface.** They may scratch the cooktop surface.
- **Do Not Let Pans Boil Dry.** This may cause permanent damage in the form of breakage, fusion, or marking that can affect the ceramic-glass cooktop. (This type of damage is not covered by your warranty).

## IMPORTANT SAFETY NOTICE

The California Safe Drinking Water and Toxic Enforcement Act requires the Governor of California to publish a list of substances known to the state to cause cancer, birth defects or other reproductive harm, and requires businesses to warn customers of potential exposure to such substances.

## INDUCTION COOKTOP FEATURES

### READ THESE INSTRUCTIONS CAREFULLY BEFORE USING THE COOKTOP

**A COOLER COOKTOP** - A unique feature of the Induction Cooktop is whether turned ON or OFF, the cooktop surface remains cooler than standard ceramic cooktops.

### CAUTION

The Cooking Zones may appear to be cool while turned ON and after they have been turned OFF. **The glass surface may be HOT** from residual heat transferred from the cookware and burns may occur.

**MAGNETIC DETECTOR** - The coil sensor automatically detects whether the pan is magnetic and eliminates accidental “turn-ONs.”

**PAN SIZE DETECTION** - The pan recognition sensor automatically detects and adapts the Cooking Zones to the pan sizes in use.

**EFFICIENT** - Induction cooking heats faster while using less energy. Induction power levels are quick to boil and when simmering.

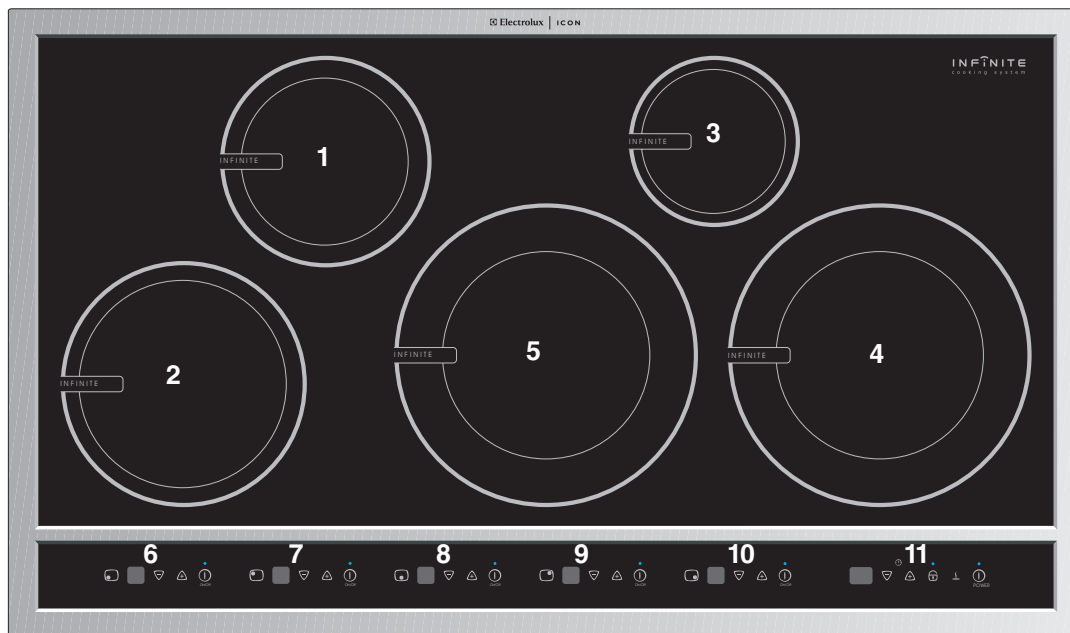

Fig. 1

1. Left Rear Cooking Zone.
2. Left Front Cooking Zone.
3. Right Rear Cooking Zone.
4. Right Front Cooking Zone.
5. Central Cooking Zone.
6. Left Front Cooking Zone Control Pads.
7. Left Rear Cooking Zone Control Pads.
8. Central Cooking Zone Control Pads.
9. Right Rear Cooking Zone Control Pads.
10. Right Front Cooking Zone Control Pads.
11. Main Cooktop Controls (See Fig 2).

# 8 Induction Cooktop Features

## INDUCTION COOKTOP FEATURES (CONT'D)

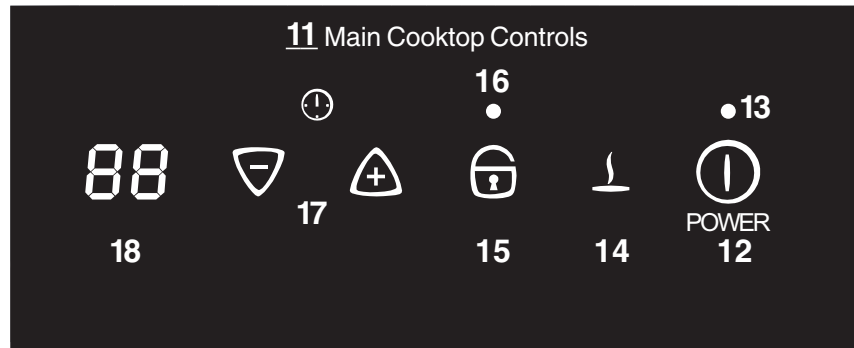

Fig 2.

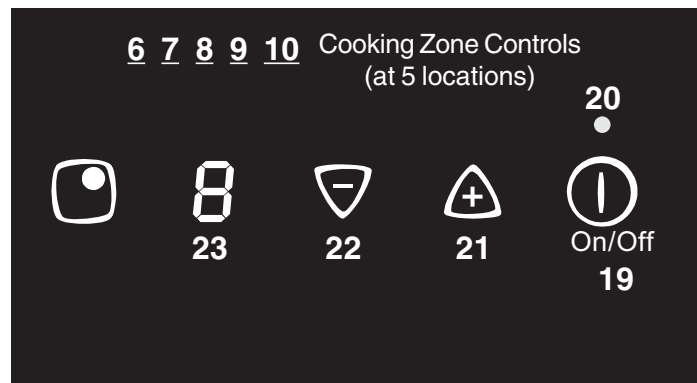

Fig 3.

- 6. Left Front Cooking Zone Control Pads.
- 7. Left Rear Cooking Zone Control Pads.
- 8. Central Cooking Zone Control Pads.
- 9. Right Rear Cooking Zone Control Pads.
- 10. Right Front Cooking Zone Pads.
- 11. Main Cooktop Controls (See Fig 2).
- 12. Cooktop Power Key Pad (See p. 9).
- 13. Cooktop Power Indicator Light (See p. 9).
- 14. Keep Warm Setting Key Pad (See pages 10 & 16).
- 15. Controls Lock Key Pad (See pages 9 & 17).
- 16. Controls Lockout Indicator Light (See pages 9 & 17).
- 17. Minute Timer Setting + (increase) / - (decrease) Key Pads (See pages 16 & 17).
- 18. Minute Timer LED (displays up to 99 minutes - (See pages 16 & 17).
- 19. Cooking Zone ON/OFF Key Pad (for each Cooking Zone).
- 20. Cooking Zone ON/OFF Indicator Light (for each Cooking Zone).
- 21. Cooking Zone + (increase) Key Pad (for each Cooking Zone).
- 22. Cooking Zone - (decrease) Key Pad (for each Cooking Zone).
- 23. Cooking Zone Power Level LED (for each Cooking Zone).

## LED MESSAGES OR LIGHT INDICATORS DISPLAYED BY MAIN CONTROL

**CONTROLS LOCK** - This feature allows the cooktop to be locked only when the cooktop is switched to OFF. Touch and hold the LOCK key pad for 5 seconds. A beep will sound and the Lock indicator light will glow (Fig. 5). Once locked, no other displays will glow and no Cooking Zones will activate. To turn the Controls Lock OFF, touch and hold the LOCK key pad for 5 seconds. A beep will sound, the Lock indicator light will turn OFF (Fig. 4) and the cooktop may be used normally (See p. 17 for more instructions).

**COOKTOP POWER** - The Cooktop POWER key pad activates the entire Cooktop. To power the cooktop, touch and hold the POWER key pad for 2 seconds. A beep will sound and the Power LED will glow (See Fig. 7). The cooktop will be in a ready mode for 10 seconds. If no other key pads are touched the Cooktop Main POWER will turn OFF automatically. To turn the Main Power OFF touch and hold the Main POWER key pad for 1 second. A beep will sound and the Power Indicator Light will turn OFF (See Fig. 6).

**Errors Codes E XX** - The control displays **E** in Cooking Zones LEDs (Fig. 8) and digits in Main Control LED (Fig. 9) together showing an error code.



Fig. 4

Fig. 5

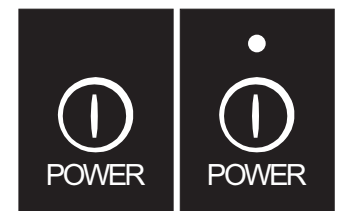

Fig. 6

Fig. 7



Fig. 8

Fig. 9

## LED MESSAGES OR LIGHT INDICATORS DISPLAYED BY COOKING ZONE CONTROLS

**COOKING ZONE ON/OFF PAD** - Each of the five Cooking Zones have separate ON/OFF key pads. Once the Main Power key pad has been touched to activate the cooktop, touch the corresponding Cooking Zone ON/OFF key pad once to activate the Cooking Zone needed. **I** will appear in the LED display. If the corresponding + (increase) / - (decrease) key pad is not touched within 10 seconds, the request to turn the Cooking Zone ON will cancel and the Cooktop Main Power will turn OFF. To set a Cooking Zone power level touch the corresponding Cooking Zone + (increase) or - (decrease) key pad once. The Cooking Zone ON/OFF Indicator Light will glow (Fig. 11). To turn OFF a Cooking Zone, touch the Cooking Zone ON/OFF key pad once. The Cooking Zone Indicator Light will turn OFF (Fig. 10).

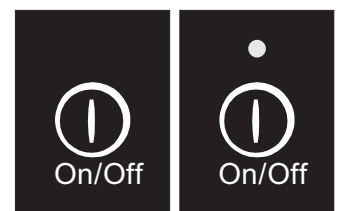

Fig. 10

Fig. 11



Fig. 12

Fig. 13

## LED MESSAGES OR LIGHT INDICATORS DISPLAYED BY COOKING ZONE CONTROLS (CONT'D)



Fig. 14



Fig. 15



Fig. 16



Fig. 17

**POWER LEVEL SETTINGS** - The Cooking Zones have five separate Power Level LEDs. Once active, the Cooking Zones will provide 10 Power Levels to choose from. These include **1**, **2**, **3**, **4**, **5**, **6** (fig. 14), **7**, **8**, **9**. The highest setting of **P** or “Power Boost” provides 125% power level for 10 minutes (See Fig. 13). Each key pad touch (or just holding down the Power Level key pad) will scroll through all the available power levels for any Cooking Zone quickly (See pages 14-17 for complete instructions).

**RESIDUAL HEAT** - Once any Cooking Zone has been used for cooking and turned OFF, and if the cooktop surface temperature on any of the Cooking Zones is still too HOT, **H** (See Fig. 15) will appear in the LED display for the affected Cooking Zone. The **H** will continue to display if the temperature is still too HOT.

### CAUTION

The Cooking Zones may appear to be cool while turned ON and after they have been turned OFF. The glass surface may be HOT from residual heat transferred from the cookware and burns may occur.

**KEEP WARM** - Use the WARM (or LOW) key pad to activate the Warm setting for any of the Cooking Zones. The ON/OFF key pad for the desired Cooking Zone must be activated first, then touch the WARM key pad located in the Cooktop Main Control area once to set. **L** (LOW) should appear in the corresponding Cooking Zone LED (See Fig. 16 & page 16 for complete information).

**PAN DETECTION** - All five Cooking Zones will provide a Pan Detection message. If a Cooking Zone is turned ON and no pan is detected for the Cooking Zone, the pan has been moved or if the pan is not centered correctly or if the pan is not made of magnetic material, **F** (See Fig. 17) will appear in the affected Cooking Zone LED display.

## USE THE CORRECT COOKWARE TYPE

The magnetic Cooking Zone sensors located below the cooktop surface require the use of cookware made with magnetic material in order to start the heating process on any of the Cooking Zones.

When purchasing pans, look for cookware specifically identified by the manufacturer for use with Induction cooktops. If your not sure, use a magnet to test whether the cookware type will work. If a magnet sticks to the bottom of the cookware, the material type is correct for Induction cooking (See Fig. 18).

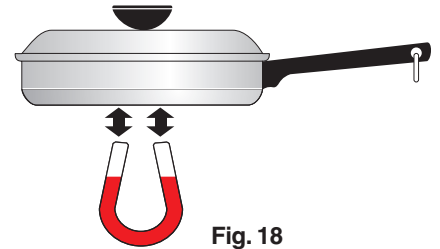

Fig. 18

It is recommended to always use heavier high quality stainless steel cookware on your Induction Cooktop surface. This will greatly reduce the possibility of developing scratches on the ceramic surface. Even quality cookware can scratch the cooktop surface, especially if cookware is slid over the ceramic cooktop surface without being lifted up. Over time sliding **ANY** type of cookware over the ceramic cooktop will likely alter the overall appearance of the cooktop. Eventually the buildup of scratches will make cleaning the surface difficult and degrade the overall appearance of the cooktop.

## MINIMUM PAN SIZE REQUIREMENTS FOR EACH COOKING ZONES

**USE THE CORRECT SIZE COOKWARE** - The 5 Cooking Zones available on the Induction Cooktop require a **MINIMUM** pan size to be used at each location (Fig. 19). The inner ring of each Cooking Zone is your guide to the correct **MINIMUM** pan size. The pan bottom must **FULLY** cover the inner ring for proper cooking to occur.

The thicker outer ring at each Cooking Zone is helpful to determine the pan **MAXIMUM** size. After centering the cookware of the cooktop, make sure the cookware does not extend more than  $\frac{1}{2}$ " beyond the thicker line on the Cooking Zone (See example in Fig. 19). The pan must make **FULL** contact on the glass surface without the bottom of the pan touching the metal cooktop trims (Shown in Fig. 19).

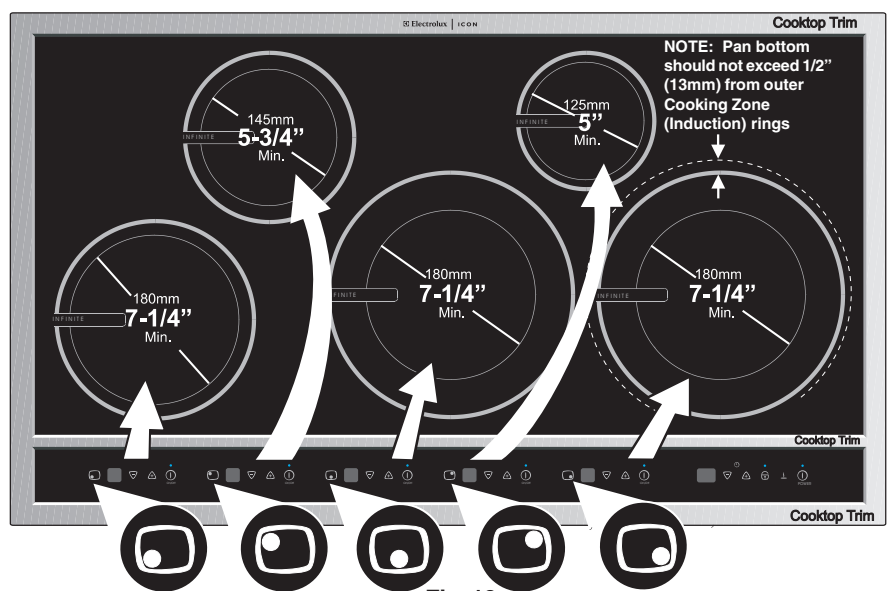

Fig. 19

**NOTE:** If a pan made of the correct material is centered properly on any of the active Cooking Zones but is **TOO SMALL**, the affected Cooking Zone LED will display an **F** code and the pan will not heat.

# 12 Before Using the Cooktop

## COOKWARE RECOMMENDATIONS

### INCORRECT



- Cookware not centered on Cooking Zone surface.



- Curved or warped pan bottoms or sides.

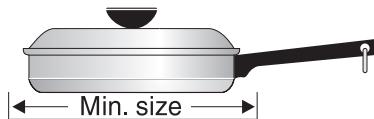

- Pan does not meet the minimum size required for the Cooking Zone used (See Fig. 19).



- Pan bottom rests on cooktop trim or does not rest completely on the cooktop surface.



- Heavy handle tilts pan.

### CORRECT



- Cookware centered correctly on Cooking Zone surface.



- Flat pan bottom & straight sides.

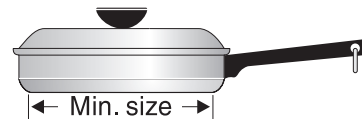

- Pan size meets or exceeds the recommended minimum size for the Cooking Zone (See Fig. 19).



- Pan rests completely on the Cooktop surface.



- Pan is properly balanced.

Fig. 20

**PLEASE NOTE - ANY one of the incorrect conditions listed above in Fig. 20 may be detected by the sensors located below the ceramic cooktop surface. If the cookware does not meet any of these conditions, one or more of the Cooking Zones will not heat indicated by an *F* in the affected Cooking Zone display. Correct the problems before attempting to activate the cooktop.**

## USE QUALITY COOKWARE IN GOOD CONDITION

The cookware used with the Induction Cooktop should have flat bottoms that make good contact with the entire surface of the Cooking Zone. Check for flatness by rotating a ruler across the bottom of the cookware (See Fig. 21). Be sure to follow all the recommendations for using cookware as shown in Fig. 20.

### Also remember to:

- Use cookware made with the correct material type for Induction Cooking (See Fig. 18).
- Use quality cookware with heavier bottoms for better heat distribution allowing for more even cooking results.
- The pan size should match the amount of food being prepared.
- **Do not let pans boil dry.** This may cause permanent damage in the form of breakage, fusion, or marring that can affect the ceramic cooktop. (This type of damage is not covered by your warranty).
- Do not use dirty pans with grease buildup. Always use pans that are easy to clean after cooking.

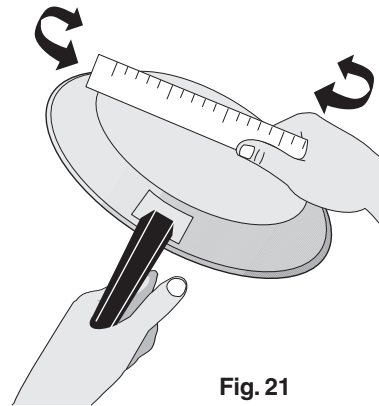

Fig. 21

### CAUTION

The Cooking Zones may appear to be cool while turned ON and after they have been turned OFF. **The glass surface may be HOT** from residual heat transferred from the cookware and burns may occur.

### CAUTION

**DO NOT TOUCH HOT COOKWARE or PANS directly with hands.** Always use oven mitts or pot holders to protect hands from burns.

### CAUTION

**DO NOT SLIDE Cookware across the cooktop surface.** Doing so may permanently damage the appearance of the ceramic cooktop.

Prior to using your cooktop for the first time, apply the recommended cooktop cleaning creme to the ceramic surface. Buff with a non-abrasive cloth or pad. This will make cleaning easier when soiled from cooking. The special cooktop cleaning cream leaves a protective finish on the glass to help prevent scratches and abrasions.

# 14 Setting Surface Controls

## USING THE TOUCH CONTROL



Fig. 22







The recommended way to use the touch pads on the cooktop is shown in Fig. 22. Be sure that your finger is placed in the center of the touch pad as shown. If the finger is not placed on the center of a pad, the cooktop may not respond to the selection made.

Lightly contact the pad with the flat part of your entire fingertip. Do not just use the narrow end of your fingertip.

## OPERATING THE COOKING ZONES





The Induction cooktop has five Cooking Zones designed for cookware of various sizes. Be sure to place cookware that meets the minimum and maximum pan size requirements (Fig. 19) for the Cooking Zone desired and is best for the amount of food being prepared. Place the cookware with the prepared food on the Cooking Zone **BEFORE** setting any of the Cooktop controls.

### To Turn ON one or more of the Cooking Zones:

1. Place the prepared food using the correct type and size cookware on the desired Cooking Zone. Be sure to center the cookware on Cooking Zone completely covering the minimum ring marked on the Zone surface. PLEASE NOTE: If the cookware requirements for the Cooking Zone (See Fig. 20) are not met the sensors will detect a problem and display the letter **F** in the affected Cooking Zone LED. Any problems must be corrected before proceeding.
2. Touch and hold the  key pad for 2 seconds (or until a beep sounds). The Power Indicator light located above the  key pad will turn ON. NOTE: If no other key pad is touched within 20 seconds the request to Power ON the cooktop will clear.
3. To start one or more of the five Cooking Zones lightly touch the  key pad for the Cooking Zones needed. A beep will sound and the chosen Cooking Zone power level digital display will show **0** indicating no power level for the Zone has been set yet. NOTE: If no other key pad is touched within 10 seconds the request to Power ON the Cooktop Zone will clear.
4. Set the desired power level for the Cooking Zone by touching either the  or  key pad. If the  key pad is touched the Cooking Zone will start at a "Power Boost" maximum power level (the Cooking Zone LED will display **P** and the control will beep once). If the  key pad is touched once the Cooking Zone will start at 1 (the Cooking Zone LED will display **1** and the control will beep once).

## OPERATING THE COOKING ZONES (CONT'D)



### To Turn ON one or more of the Cooking Zones (cont'd)

NOTE: Touch once, or repeatedly touch the  or  key pads to adjust or scroll through power levels at any time during the cooking process (To scroll through the power levels quickly touch and hold the  or  key pads until the power level desired is reached). Once the Cooking Zone power level has been set the food will begin to heat at that level until the power level is manually changed. For more information about the available Cooktop Zones power levels available see “Power Level Settings” section on page 10.

### IMPORTANT OPERATING NOTES:

- Fluids spilled or objects lying on the controls area of the cooktop may cause the cooktop to display error code and turn OFF while cooking. Clean the spills or remove the objects from the cooktop.
- Be sure the cooktop vent holes are NOT blocked. If the vent holes are blocked the cooktop internal sensor may shut OFF of the cooktop to avoid over heating the appliance.
- If the cookware or pan is moved from the center of any active Cooking Zone for any reason, a sensor will detect the situation and the cookware will no longer heat. The affected Cooking Zone LED will flash between **F** and the last power level set for the Cooking Zone. The Cooking Zone will remember the power level setting for up to 3 minutes before the Cooking Zone will automatically shut OFF.

### To Turn OFF the Cooking Zones:

1. Once cooking is complete, touch the  key pad to turn the Cooking Zone OFF.
2. The corresponding Cooking Zone ON/OFF Indicator light located above the  key pad will turn OFF. A beep will sound and the chosen Cooking Zone power level LED will display **0**. If no other key pads are touched the Cooking Zone will shut OFF automatically in 10 seconds. If no other Cooking Zones are active and no other key pads are touched the entire cooktop will shut OFF automatically in 20 more seconds.
3. When any Cooking Zone is OFF, the corresponding Cooking Zone LED may display **H** if the Cooking Zone temperature is too HOT. The LED will continue to display **H**, and even if the Cooktop is switched OFF the LED will continue to display **H** as long as the cooktop remains HOT.

## CAUTION

The Cooking Zones may appear to be cool while turned ON and after they have been turned OFF. **The glass surface may be HOT** from residual heat transferred from the cookware and burns may occur.

# 16 Setting Surface Controls

## PREHEAT RECOMMENDATIONS



When preheating a pan on the cooktop always watch carefully. Whenever using the cooktop the user should always pay attention to any items cooking and remain attentive until the cooking process is complete.

Keep in mind that induction may decrease the amount of time required to preheat a cooking utensil.

## KEEP WARM FEATURE

The Warm feature may be used with any of the Cooking Zones.





### To Turn the Keep Warm Feature ON:

1. To select the Keep Warm feature for any Cooking Zone touch the  key pad for the corresponding Cooking Zone.
2. Touch the  key pad located in the main control area. The Cooking Zone will display  (LOW) indicating that the Cooking Zone is properly set to Keep Warm. If no other key pads are pressed for a period of 5 seconds the control will activate the desired Cooking Zone at the Keep Warm setting (See Fig. 16).

## MINUTE TIMER





The Minute Timer feature may be useful in the kitchen if a recipe calls for keeping track of time. This feature will keep track of time from 1 to 99 minutes. The LED display located to the left of the Timer UP/DOWN arrow key pads will begin to count down minutes once set.

### To Set the Minute Timer:

1. Touch the  listed under the symbol . Touching and releasing the  or the  key pads will increase or decrease the Minute Timer setting by 1 minute with each key press (up to **99** minutes).
2. Once the Timer LED displays the desired amount of time, release the UP or DOWN Arrow key pads. The Minute Timer LED will flash the time with a small dot to the right. Once the LED quits flashing and the dot disappears the MinuteTimer will begin the countdown with remaining minutes. Once the Minute Timer reaches **00** a long beep will sound indicating that the time is up.

## MINUTE TIMER





### To Cancel the Minute Timer:

1. Touch the  and  key pads at the same time or touch and hold either the  or  key pad and scroll to **00**.
2. If cancelling the Minute Timer using the scrolling method, once the Main Control LED reaches **00**, release the Arrow key pad.
3. The LED will flash momentarily and then quit flashing. The set time will disappear from the LED indicating that the MinuteTimer is no longer active.





## LOCKING THE CONTROLS

The Induction Cooktop may be locked in order to prevent the cooktop from accidentally being turned ON.

### To Turn ON the Controls Lock Feature:

1. The Cooktop Lock will not activate until the cooktop is OFF. If the cooktop power is not OFF, touch and hold the  key pad until a beep sounds (about 1 second). The Power Indicator light located above the  key pad will turn OFF.
2. Touch the  key pad. After 5 seconds a beep will sound. The Lock Indicator Light above the  key pad will turn ON indicating the cooktop is locked. This will keep any Cooking Zone or Cooktop functions from being accidentally turned ON (See Fig. 5)

### To Turn OFF the Controls Lock Feature:

1. Touch the  key pad. After 5 seconds a beep will sound. The Lock Indicator Light above the  key pad will turn OFF indicating the cooktop is unlocked. The Cooking Zones or any of the other Cooktop functions may now be used (See Fig. 4).
2. If the cooktop is needed you must touch and hold the  key pad until a beep sounds (about 1 second). The Power Indicator Light located above the  key pad will turn ON. (See Fig. 7). You may now activate any of the Cooking Zones.

# 18 Setting Surface Controls

## POWER SHARING

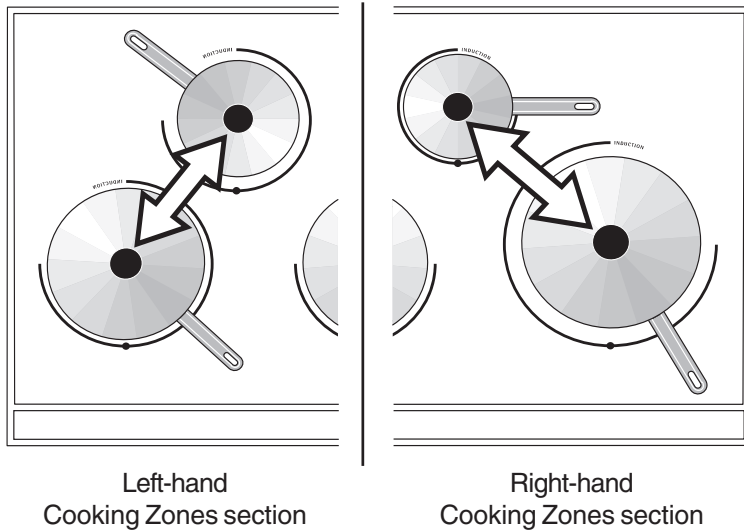

Fig. 23

Your cooktop is equipped with five induction elements within three heating sections. The right-hand, left-hand and center Cooking Zones are powered by three independent induction inverters - one inverter for each heating section. Two Cooking Zones in a heating section share the power of one inverter. This is called Power Sharing.

A third heating section is used to power the Center zone induction element. There is no power sharing for the center zone.

For example, if pans are cooking food items on both right-hand Cooking Zones, the last Power Level set will be maintained, while the first pan may experience a slight reduction in the power level setting.

**POWER SHARING TIPS:** Remember to set the power level for the food item you wish to maintain last. Or, you may choose to maintain a constant power level for 2 food items by placing the pans on one of the Cooking Zones of the left-hand heating section and the other pan on the Center Cooking Zones or on one of the Cooking Zones of the right-hand heating section (See Fig. 23).

## OPERATIONAL NOISES

The electronic processes involved with Induction Cooking create some unusual background noises. These noises are normal and part of the Induction Cooking process.

Please note that these noises are more noticeable while cooking at the Power BOOST level. Very loud noises are not part of normal Induction Cooking.

## CERAMIC GLASS COOKTOP CLEANING & MAINTENANCE

Consistent and proper cleaning is essential to maintaining your ceramic glass cooktop

Prior to using your cooktop for the first time, apply the recommended CookTop® Cleaning Creme to the ceramic surface. Buff with a **non-abrasive** cloth or **no-scratch** cleaning pad. This will make cleaning easier when soiled from cooking. The special cooktop cleaning cream leaves a protective finish on the glass to help prevent scratches and abrasions.

Sliding aluminum or copper clad bottom pans on the cooktop can cause metal markings on the cooktop surface. These marks should be removed **immediately** after the cooktop has cooled using the cooktop cleaning cream. Metal marks can become permanent if not removed prior to future use.

Cookware (cast iron, metal, ceramic or glass) with rough bottoms can mark or scratch the cooktop surface. **Do not slide anything metal or glass** across the cooktop. **Do not** use your cooktop as a cutting board or work surface in the kitchen. **Do not** cook foods directly on the cooktop surface without a pan. **Do not** drop heavy or hard objects on the glass cooktop, because they may cause it to crack.

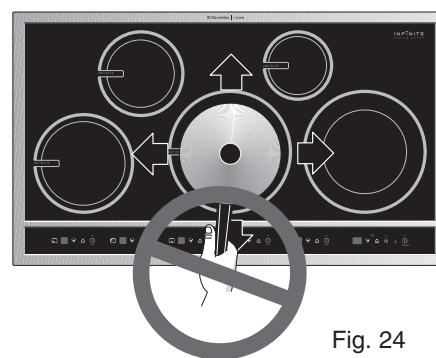

Fig. 24

## CLEANING RECOMMENDATIONS FOR CERAMIC GLASS COOKTOP

### ⚠ CAUTION

Before cleaning the cooktop, be sure the controls are turned to OFF and the cooktop is COOL.

### ⚠ WARNING

DO NOT use a cooktop cleaner on a hot cooktop. The fumes can be hazardous to your health, and can chemically damage the ceramic-glass surface.

#### For light to moderate soil:

Apply a few drops of CookTop® Cleaning Creme directly to the cooktop. Use a paper towel or use a **non-abrasive** plastic type **no-scratch** pad to clean the entire cooktop surface. Make sure the cooktop is cleaned thoroughly, leaving no residue.

#### For heavy, burned on soil:

Apply a few drops of CookTop® Cleaning Creme directly to the soiled area. Rub the soiled area using a **non-abrasive** plastic type **no-scratch** pad, applying pressure as needed. Do not use the pad you use to clean the cooktop for any other purpose.

# 20 General Care & Cleaning

## CLEANING RECOMMENDATIONS FOR THE CERAMIC GLASS COOKTOP (CONTINUED)

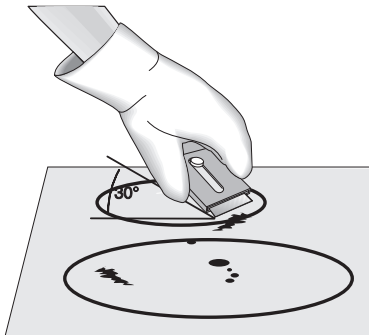

Fig. 25

If soils remain, carefully scrape soils with a metal razor blade scraper, holding scraper at a 30 degree angle to the surface. Remove loosened soils with cooktop cleaning cream and buff surface clean.

**IMPORTANT NOTE:** Damage to the ceramic glass cooktop may occur if you use an abrasive type scratch pad. Only use cleaning products that have been specifically designed for ceramic glass cooktop.

### Plastic or foods with a high sugar content:

These types of soils need be removed immediately if spilled or melted onto the ceramic cooktop surface. Permanent damage (such as pitting of the cooktop surface) may occur if not removed **immediately**. After turning the surface elements OFF, use a razor blade scraper or a metal spatula with a mitt and scrape the soil from the hot surface (as illustrated). Allow the cooktop to cool, and use the same method for heavy or burned on soils.

### Do not use the following on the ceramic cooktop (See Fig. 26):

- Do not use abrasive cleaners and scouring pads, such as metal and some nylon pads. They may scratch the cooktop, making it more difficult to clean.
- Do not use harsh cleaners, such as chlorine bleach, ammonia or oven cleaners, as they may etch or discolor the cooktop.
- Do not use dirty sponges, cloths or paper towels, as they can leave soil or lint on the cooktop which can burn and cause discoloration.



Fig. 26

### Special Caution for Aluminum Foil and Aluminum Cooking Utensils

- **Aluminum foil** - Use of aluminum foil will damage the cooktop. Do not use thin aluminum cooking utensils or allow foil to touch the ceramic cooktop under ANY circumstances.
- **Aluminum utensils** - The melting point of aluminum is much lower than that of other metals. Care must be taken when aluminum pots or pans are used on the cooktop. If allowed to boil dry, not only will the utensil be destroyed, but it may fuse to, break or mark the ceramic glass surface, permanently damaging the cooktop surface.

### CLEANING IMPORTANT NOTE:

Liquid, cleaning towel or objects on the control area of the cooktop display could cause the cooktop displays an error code or momentarily disable touch control operation.

## IMPORTANT

Before calling for service, review the following problems first. It may save you both time and expense. This list includes common experiences that are not the result of defective workmanship or material in your cooktop.

## ENTIRE COOKTOP DOES NOT OPERATE

- Cooktop controls are locked. Set the cooktop controls to unlock the Cooktop (See p. 17 for further instructions).
- Make sure household electrical circuit breaker is ON and that power is properly supplied to the Cooktop.
- Service wiring not complete. Contact installation agent or dealer.
- Power outage. Check house lights to be sure. Call local electric company.

## COOKTOP TURNS OFF WHILE COOKING

- **The automatic shut-off feature will turn all of the Cooking Zones and the entire Cooktop OFF after any Cooking Zone has been in continuous use for 18 hours.**
- Cooktop internal heat sensor has detected high temperatures inside the appliance. Be sure the appliance vent holes are not blocked. **(Refer to the Installation Instructions supplied with the cooktop for more detailed cooktop installation information).**
- Fluids spilled or object lying on controls area of cooktop. Clean spills or remove object. Repower cooktop.

## COOKING ZONE DOES NOT HEAT FOOD

- No cookware was placed on the Cooking Zone or cookware material type incorrect for Induction Cooking (See Figs. 18 & 20).
- Cookware bottom not large enough for Cooking Zone (See Fig. 19).
- Cookware is warped or in poor condition (See Figs. 20 & 21).
- Cookware is not centered on Cooking Zone (See Fig. 20).
- Cookware resting on cooktop trim or does not rest completely on cooktop surface (See Figs. 19 & 20).
- No power to the appliance. Check steps under "**Entire cooktop does not operate**" in this checklist.
- Incorrect Cooking Zone control setting. Make sure the correct control is ON for the Cooking Zone being used.

## COOKING ZONE HEATS FOOD TOO HOT OR NOT HOT ENOUGH

- Incorrect power level setting. Adjust the power level setting higher or lower and refer to recipe for guidance and adjust accordingly.

## FOOD DOES NOT HEAT EVENLY

- Lightweight or warped pans were used. Be sure to use good quality cookware (Refer to Figs. 20 & 21).
- Use only flat bottom, evenly balanced medium or heavyweight cookware. Heavy and medium weight pans heat evenly. Because lightweight pans heat unevenly, foods may burn more easily (See pages 12 & 13 for further information).
- Adjust Cooking Zone power level setting until the proper amount of heat is obtained.

## POOR COOKING RESULTS

- Many factors affect cooking results. Adjust the recipe's recommended power levels or cooking times.
- Cookware is too lightweight or warped. Use heavier quality cookware so foods being prepared may cook more evenly.

## COOKTOP ZONE CONTROL DISPLAYS $\epsilon$ AND 2 DIGITS LED MAIN CONTROL DISPLAYS

- Induction Cooktop main control has detected a fault or error condition. Try turning electrical power supply OFF and back ON to cooktop in order to reset Cooktop main controls. If fault recurs, record fault number and turn power supply to Cooktop OFF.

## COOKING ZONE LED CONTINUOUSLY FLASHES $F$

- Induction Cooktop pan detection sensors do not see the correct cookware. Test with a magnet to be sure cookware is made with Induction compatible material.
- Cookware has been removed from the Cooking Zone without turning the Cooking Zone OFF. Place cookware back on to the Cooking Zone or if finished cooking turn off the affected Cooking Zone.
- Cookware is not centered over the Cooking Zone properly. Refer to Fig. 20 for correct cookware placement.

## METAL MARKS ON CERAMIC COOKTOP GLASS

- Sliding or scraping of metal utensils on cooktop surface. DO NOT slide cookware or cooking utensils across the cooktop surface. Use the recommended ceramic glass cooktop cleaning creme to remove the marks. See "Cooktop Cleaning & Maintenance" in the **General Care & Cleaning** section (Refer to ps. 19 & 20).

## SCRATCHES OR ABRASIONS ON CERAMIC COOKTOP GLASS

- Coarse particles such as salt or sand between cooktop and cookware or cooking utensils can cause scratches. Be sure cooktop surface and bottoms of utensils are clean before placing on cooktop. Small scratches do not affect cooking and will become less visible with time.
- Cleaning materials not recommended for ceramic-glass cooktop have been used. See "Cooktop Cleaning & Maintenance" in the **General Care & Cleaning** section.
- Cookware with rough bottoms were used. Use smooth, flat-bottomed cookware ONLY (See Figs. 20 & 21).

## BROWN STREAKS OR SPECKS ON CERAMIC COOKTOP SURFACE

- Boil overs are cooked onto cooktop surface. Use a razor blade scraper to remove soil. See "Cooktop Cleaning & Maintenance" in the **General Care & Cleaning** section (Refer to ps. 19 & 20).

## AREA OF DISCOLORATION WITH METALLIC SHEEN ON CERAMIC COOKTOP GLASS

- Mineral deposits from food and/or water. Remove using a ceramic-glass cooktop cleaning creme. Remember to use cookware with clean, dry bottoms. For more information See "Cooktop Cleaning and Maintenance" in the **General Care & Cleaning** section.

# 24 Warranty Information

## **COOKTOP WARRANTY** *Your cooktop is protected by this warranty*

In the **U.S.A.**, your appliance is warranted by Electrolux Home Products North America, a division of White Consolidated Industries, Inc. We authorize no person to change or add to any of our obligations under this warranty. Our obligations for service and parts under this warranty must be performed by us or an authorized Electrolux Home Products North America servicer. In **Canada**, your appliance is warranted by Electrolux Canada Corp.

	WARRANTY PERIOD	THROUGH OUR AUTHORIZED SERVICERS, WE WILL:	THE CONSUMER WILL BE RESPONSIBLE FOR:
<b>FULL ONE-YEAR WARRANTY</b>	One year from original purchase date	Pay all costs for repairing or replacing any parts of this appliance which prove to be defective in materials or workmanship.	Costs of service calls that are listed under NORMAL RESPONSIBILITIES OF THE CONSUMER. *
<b>LIMITED 2<sup>ND</sup>-5<sup>TH</sup> YEAR WARRANTY</b> (Glass Smoothtop, Seal & Elements)	Second through fifth years from original purchase date	Provide a replacement for any defective surface heating element, deteriorated rubberized-silicone seal (upswept models only), or glass smoothtop that cracks due to thermal breakage ( <b>not customer abuse</b> ).	Diagnostic and any transportation and labor costs which are required because of service.
<b>LIMITED WARRANTY</b> (Applicable to the State of Alaska)	Time periods listed above.	All of the provisions of the full and limited warranties above and the exclusion listed below apply.	Costs of the technician's travel to the home and any costs for pick up and delivery of the appliance required because of service.

### \*NORMAL RESPONSIBILITIES OF THE CONSUMER

**This warranty applies only to products in ordinary household use, and the consumer is responsible for the items listed below:**

1. Proper use of the appliance in accordance with instructions provided with the product.
2. Proper installation by an authorized servicer in accordance with instructions provided with the appliance and in accordance with all local plumbing, electrical and/or gas codes.
3. Proper connection to a grounded power supply of sufficient voltage, replacement of blown fuses, repair of loose connections or defects in house wiring.
4. Expenses for making the appliance accessible for servicing, such as removal of trim, cupboards, shelves, etc., which are not a part of the appliance when it was shipped from the factory.
5. Damages to finish after installation.
6. Replacement of light bulbs and/or fluorescent tubes (on models with these features).

### EXCLUSIONS

**This warranty does not cover the following:**

1. CONSEQUENTIAL OR INCIDENTAL DAMAGES SUCH AS PROPERTY DAMAGE AND INCIDENTAL EXPENSES RESULTING FROM ANY BREACH OF THIS WRITTEN OR ANY IMPLIED WARRANTY.  
**NOTE:** Some states do not allow the exclusion or limitation of incidental or consequential damages, so this limitation or exclusion may not apply to you.
2. Service calls which do not involve malfunction or defects in workmanship or material, or for appliances not in ordinary household use. The consumer shall pay for such service calls.
3. Damages caused by services performed by servicers other than Electrolux Home Products North America or its authorized servicers; use of parts other than genuine Electrolux Home Products parts; obtained from persons other than such servicers; or external causes such as abuse, misuse, inadequate power supply or acts of God.
4. Products with original serial numbers that have been removed or altered and cannot be readily determined.

### IF YOU NEED SERVICE

Keep your bill of sale, delivery slip, or some other appropriate payment record. The date on the bill establishes the warranty period should service be required. If service is performed, it is in your best interest to obtain and keep all receipts. This written warranty gives you specific legal rights. You may also have other rights that vary from state to state. Service under this warranty must be obtained by contacting Electrolux Home Products:

**USA**  
**1•800•944•9044**  
 Electrolux Home Products  
 North America  
 P.O. Box 212378  
 Augusta, GA 30917

**Canada**  
**1•866•294•9911**  
 Electrolux Home Products  
 North America  
 802, boul. L'Ange-Gardien  
 L'Assomption, Québec  
 J5W 1T6

This warranty only applies in the 50 states of the U.S.A., Puerto Rico, and Canada. Product features or specifications as described or illustrated are subject to change without notice. All warranties are made by Electrolux Home Products North America, a division of White Consolidated Industries, Inc. In **Canada**, your appliance is warranted by Electrolux Canada Corp.